

INLINE COLUMN OPTIONS

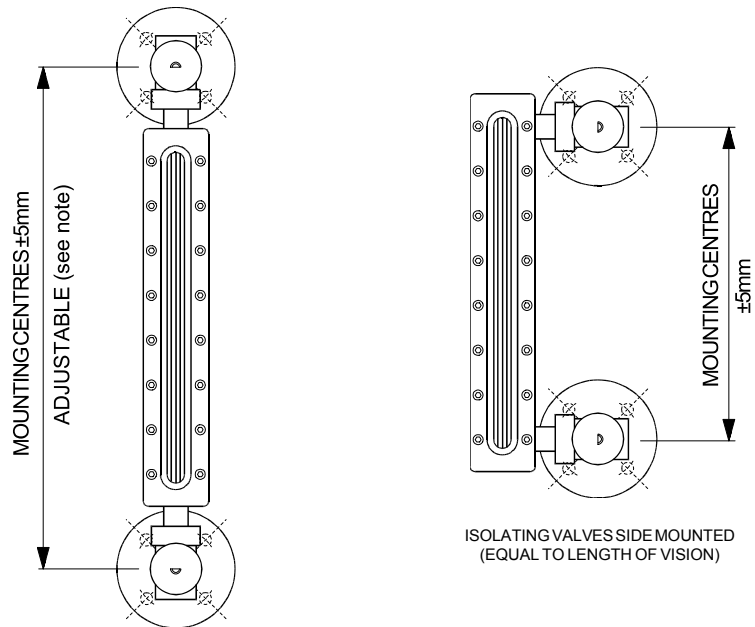

STRAIGHT MOUNTED

SIDE MOUNTED

PLEASE REFER TO ACCOMPANYING DATA-SHEET FOR OPTIONAL ISOLATING VALVES

NOTES

The centres of the gauge marked Adjustable can be adjusted by the addition of a suitable length adaptor post between the top of the column and the top valve, standard gauge centres are as per table given.

The centres of the gauge marked $\pm 5\text{mm}$ is only supplied as stated in the table with $\pm 5\text{mm}$ tolerance to aid fitting.



SEETRU LIMITED

ALBION DOCKSIDE WORKS, BRISTOL. BS1 6UT
 TELEPHONE +44 (0) 117 927 9204, FAX +44 (0) 117 929 8193
 www.seetru.com enquiries@seetru.com

INLINE COLUMN MOUNTING CENTRES

Table showing gauge mounting centres for standard inline column assemblies.

	LENGTH OF VISION								
	216	308	496	588	680	776	868	960	1052
STRAIGHT MOUNTED	340	433	621	713	805	901	993	1085	1177
SIDE MOUNTED	216	308	496	588	680	776	868	960	1052
No. of Chambers	1	1	2	2	2	3	3	3	3

	LENGTH OF VISION								
	1056	1148	1240	1332	1336	1424	1428	1520	1612
STRAIGHT MOUNTED	1181	1273	1365	1457	1461	1549	1553	1645	1737
SIDE MOUNTED	1056	1148	1240	1332	1336	1424	1428	1520	1612
No. of Chambers	4	4	4	4	5	4	5	5	5

	LENGTH OF VISION								
	1616	1704	1708	1796	1800	1892	1896	1984	1988
STRAIGHT MOUNTED	1741	1829	1833	1921	1925	2017	2021	2109	2113
SIDE MOUNTED	1616	1704	1708	1796	1800	1892	1896	1984	1988
No. of Chambers	6	5	6	5	6	6	7	6	7

CONNECTION TYPES

1" BS10 TABLE D
 1" ASA 150 RF
 25mm BS4504 TABLE 10

1" BS10 TABLE J
 1" ASA 300 RF
 25mm BS4504 TABLE 40

TECHNICAL DATA

Maximum operating pressure = 35 Bar.g
 Maximum operating temperature = 250°C
 Minimum operating temperature = 0°C (without frost guard)
 0°C to -30°C with frost guard.

All temperatures are subject to seal material and pressure.

MATERIALS

Gauge chamber: Stainless Steel 316
 Reflex glass: Borosilicate BS3463
 Chamber seals available: Viton®, Nitrile, Neoprene, Ethylene propylene, P.T.F.E.
 Glass to chamber seal: Asbestos free gasket
 Valve body: Stainless Steel 316
 Valve seal material: P.T.F.E.

REFLEX GAUGE DETAILS
CPI ISOLATING VALVES
RC0103

OFFSET COLUMN OPTIONS

Provides uninterrupted viewing over entire mounting centres

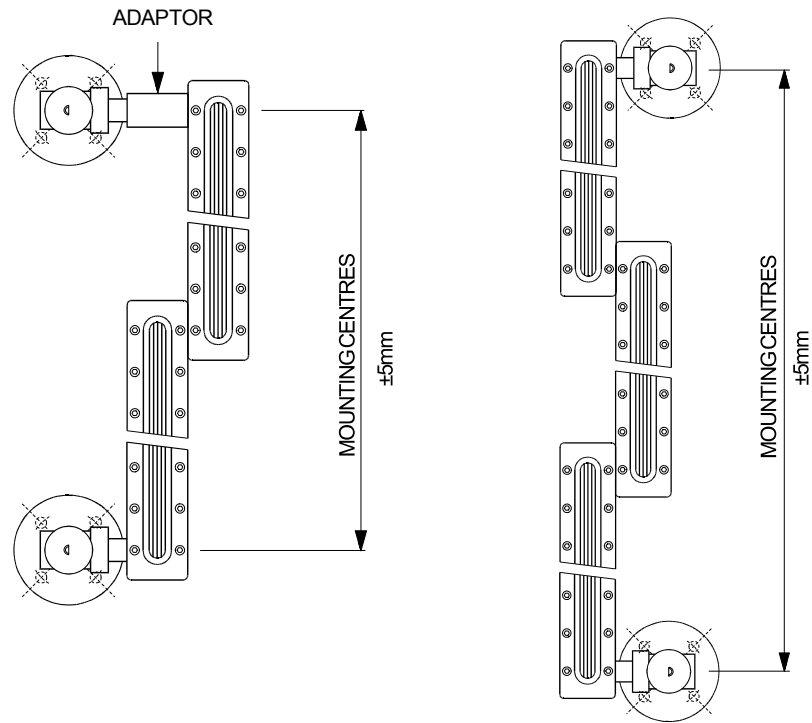

SIDE MOUNTED EVEN

SIDE MOUNTED ODD

PLEASE REFER TO ACCOMPANYING DATA-SHEET FOR OPTIONAL ISOLATING VALVES



NOTES

The centres of these gauges are only supplied as stated in tables with $\pm 5\text{mm}$ tolerance to aid fitting.

SEETRU LIMITED

ALBION DOCKSIDE WORKS, BRISTOL. BS1 6UT
 TELEPHONE +44 (0) 117 927 9204, FAX +44 (0) 117 929 8193
 www.seetru.com enquiries@seetru.com

OFFSET COLUMN MOUNTING CENTRES

Table showing gauge mounting centres for standard offset column assemblies.

	LENGTH OF VISION								
	216	308	432	524	616	648	740	832	864
SIDE MOUNTED	216	308	432	524	616	648	740	832	864
No. of Chambers	1	1	2	2	2	3	3	3	4

	LENGTH OF VISION								
	924	956	1048	1080	1140	1172	1232	1264	1296
SIDE MOUNTED	924	956	1048	1080	1140	1172	1232	1264	1296
No. of Chambers	3	4	4	5	4	5	4	5	6

	LENGTH OF VISION								
	1356	1388	1448	1480	1512	1540	1572	1664	1728
SIDE MOUNTED	1356	1388	1448	1480	1512	1540	1572	1664	1728
No. of Chambers	5	6	5	6	7	5	6	6	8

	LENGTH OF VISION								
	1756	1820	1848	1912	1944	2004	2036	-	-
SIDE MOUNTED	1756	1820	1848	1912	1944	2004	2036	-	-
No. of Chambers	6	8	6	8	9	8	9	-	-

CONNECTION TYPES

1" BS10 TABLE D
 1" ASA 150 RF
 25mm BS4504 TABLE 10

1" BS10 TABLE J
 1" ASA 300 RF
 25mm BS4504 TABLE 40

TECHNICAL DATA

Maximum operating pressure = 35Bar.g
 Maximum operating temperature = 250°C
 Minimum operating temperature = 0°C (without frost guard)
 0°C to -30°C with frost guard.

All temperatures are subject to seal material and pressure.

MATERIALS

Gauge chamber: Stainless Steel 316
 Reflex glass: Borosilicate BS3463
 Chamber seals available: Viton®, Nitrile, Neoprene, Ethylene propylene, P.T.F.E.
 Glass to chamber seal: Asbestos free gasket
 Valve body: Stainless Steel 316
 Valve seal material: P.T.F.E.

REFLEX GAUGE DETAILS CPI ISOLATING VALVES RC0203

OPTIONAL C.P.I VALVES WITH DRAIN FACILITY

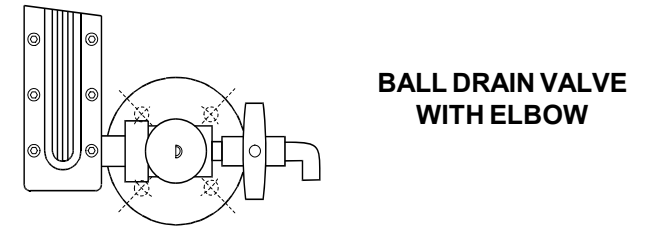
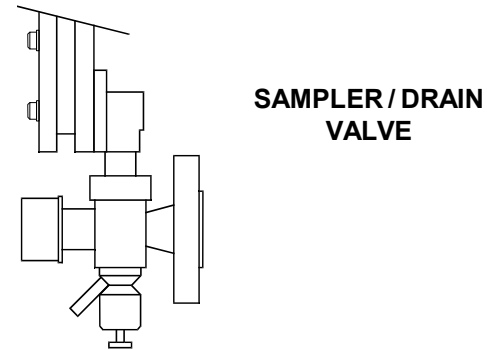
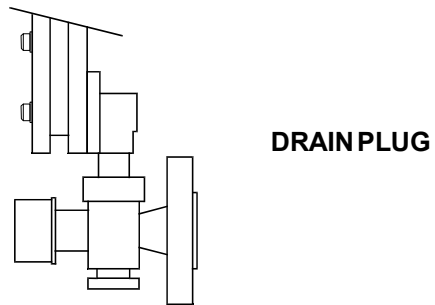
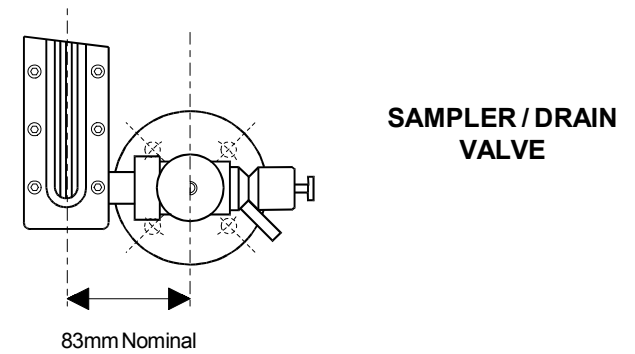
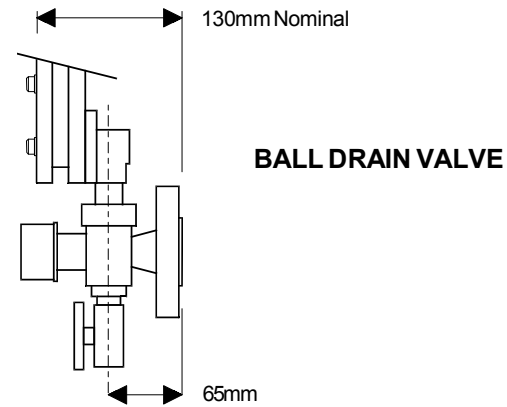
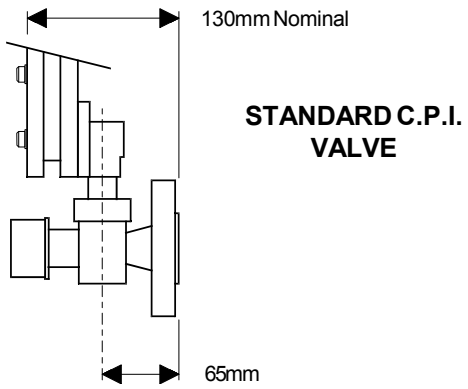

STRAIGHT MOUNTED

SIDE MOUNTED

Note: All CPI isolating valves are screwdown type with ball check valve.



SEETRU LIMITED
 ALBION DOCKSIDE WORKS, BRISTOL. BS1 6UT
 TELEPHONE +44 (0) 117 927 9204, FAX +44 (0) 117 929 8193
 www.seetru.com enquiries@seetru.com

**REFLEX GAUGE OPTIONAL
 CPI ISOLATING VALVES
 RC0303**